

## SIMULATION OF GALVANIC ELEMENTS TESTED FOR EXPLOSIVE ATMOSPHERES

MARIUS DARIE<sup>1</sup>, EMILIAN GHICIOI<sup>2</sup>, TIBERIU CSASZAR<sup>3</sup>,  
COSMIN COLDA<sup>4</sup>, DĂNUȚ GRECEA<sup>5</sup>, ADRIANA ANDRIȘ<sup>6</sup>,  
GABRIELA PUPĂZAN<sup>7</sup>

**Abstract:** The paperwork presents aspects regarding a capacitive model for the galvanic elements used in the apparatus intended for use in explosive atmospheres.

In the first part was presented the explosion risk. The explosion risk, involved by the presence of the equipment in areas characterized by the presence of flammable substances is manifested through two sources of risk. The spark ignition could occur due to the electrical equipment, mechanical impact and electrostatic discharges. Also, flammable substances could be ignited by hot surfaces. Additionally, was also included, a short presentation of intrinsic safety type of protection. In the second part was exposed the proposed theoretical model of galvanic elements.

The third part of the paper was allocated to the presentation of the test stand, to the results obtained from the tests and discussion. Also, with this occasion it was analyzed the correspondence of the proposed theoretical model with experimental test results. From the test results was obtain the value of equivalent electrical capacity of the galvanic elements which is visible at the first part of discharge. This achievement facilitates the assessment of ignition risk due to capacitive circuit.

**Keywords:** galvanic elements, intrinsic safety, explosion risk.

### 1. INTRODUCTION

The power plants and not only are touched by the artificial intelligence and its branches. Thus, the low current installations became very important.

---

<sup>1</sup> Sc. Res. I<sup>st</sup>, PhD.Eng., INCD INSEMEX Petrosani, Marius.Darie@insemex.ro

<sup>2</sup> Sc. Res. I<sup>st</sup>, PhD.Eng., INCD INSEMEX Petrosani, Emilian.Ghicioi@insemex.ro

<sup>3</sup> Sc. Res. I<sup>st</sup>, PhD.Eng., INCD INSEMEX Petrosani, Tiberiu.Csaszar@insemex.ro

<sup>4</sup> Sc. Res. II<sup>nd</sup>, PhD.Eng., INCD INSEMEX Petrosani, Cosmin.Colda@insemex.ro

<sup>5</sup> Sc. Res. III<sup>rd</sup>, PhD.Eng., INCD INSEMEX Petrosani, Danut.Grecea@insemex.ro

<sup>6</sup> Sc. Res., Eng., INCD INSEMEX Petrosani, Adriana.Andris@insemex.ro

<sup>7</sup> Asist.Res., Ph.D..Stud, INCD INSEMEX Petrosani, Gabriela.Pupazan@insemex.ro

The explanation of the observed trend is due to the advantages of increased efficiency, flexibility and safety. In the process of implementation, the information systems play an important role.

On the other hand, the wireless networks have an increased share in the industrial networks. The equipment which is not wired needs an internal source of energy. Usually this need is achieved by using galvanic elements.

But technological processes involve frequently flammable substances and, because of that, the formation of areas with increased explosion risks represents important issues [2].

In EU, placing on the market of the equipment designed for use in potentially explosive atmospheres is regulated by the European Directive 2014/34/EU (2014) which is nicknamed ATEX.

It mentions the technical requirements for the non-ignition capability or explosion protection of the equipment. For the electrical equipment, the technical solutions and requirements are stated by the specific standard [5].

“Low current equipment” represents the equipment that use electricity for the transfer of information. These, shall comply with specific requirements to guarantee the safe operation in areas endangered by the presence of flammable substances [4].

Although the equipment is low current type, however it has an ignition potential due to the low ignition threshold [5]. The ignition threshold values range from 20 to over 180  $\mu$ J. Therefore, the use of explosion protected low-current equipment and installations is required [3].

The explosion risk generated by the presence of technical equipment in areas endangered by the flammable substances is expressed through their sources of ignition (spark ignition due to electrical equipment, mechanical impact and electrostatic discharges and so on) [4]. The hot surfaces [2] could also ignite the mixtures of air with flammable substances.

The intrinsic safety type of protection suppresses ignition sources by lowering the electrical energy in circuits considered to be an ignition source. The faults of components, connections and separations between circuits are also, taken into account. The designing process of explosion protection takes into account all failure scenarios

which include both normal and failure operation modes. Using failure scenarios, the ATEX Directive splits equipment into categories (1, 2 or 3). In the same manner, IEC standard (EN 60079-0, 2018) categorize the equipment based on the protection levels (a, b and c).

## **2. THE TESTS OF GALVANIC ELEMENTS**

The galvanic elements are used in portable apparatus for communication, various measurements etc. Galvanic elements are of two types: cells which cannot be recharged (primary cells) and cells which can be recharged (secondary cells). The intrinsic safety type of protection addresses also supercapacitors, those being in fact galvanic elements.

## SIMULATION OF GALVANIC ELEMENTS TESTED FOR EXPLOSIVE ATMOSPHERES

The specific standard for intrinsic safety type of protection, imposes tests which are addressing the thermal ignition risks, but also the spark ignition risks.

In the process of testing for thermal ignition aspects, the outputs are represented by the maximum temperature and lower internal resistance. For conducting this test, ten samples are needed to be submitted to a short circuit while the temperatures reach their maximum value.

For the purpose of finding the inner capacitance is used short-circuit test which is the same test as it is used for surface temperature.

The process of galvanic elements testing is presented in figure 1.

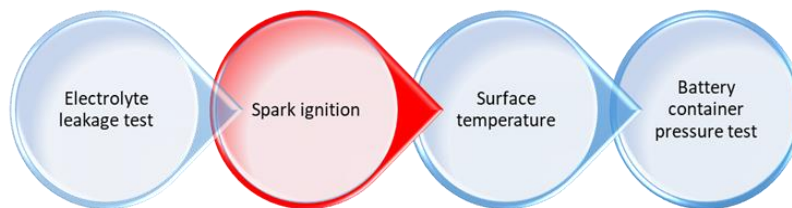

Fig. 1. The tests of galvanic elements

### 3. THEORETICAL MODEL FOR GALVANIC ELEMENTS

Having in view, that in the electronic equipment are used secondary type of galvanic elements called hyper capacitors and knowing that capacitive circuits could ignite flammable substances, the internal capacitance is the required parameter.

In figure 2 is proposed an equivalent circuit for the galvanic element which could explain its behavior in the discharging process.

Mainly, the proposed model of galvanic element consists of one DC source, a capacitor and two resistors in series. All other components in the schematic (see figure 2) are provided in order to facilitate the simulation of the circuit.

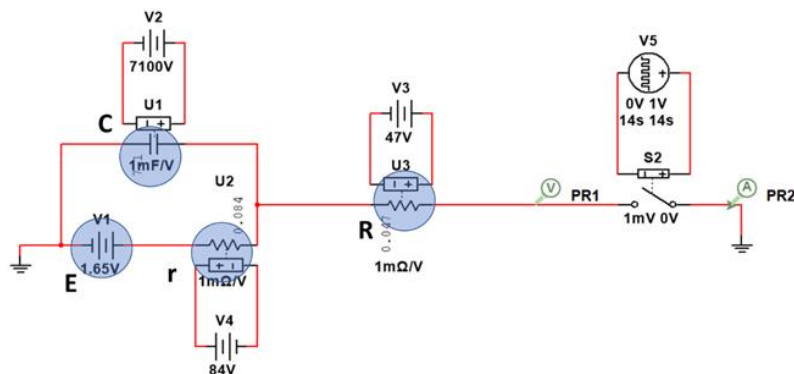

Fig. 2. Proposed theoretical model for galvanic element

Based on experimental results, the parameters of components used in the above model would be established.

Using equation (2) the values for R can be found. The equivalent capacitance C will be found through linear regression using transformed data according equation (3). Value of E is known because the electrochemical system of the galvanic element is known (for L type E = 1.65 V) [6]. The  $i(0)$  means the current value at the very beginning of the discharge.

Having in view the RC circuits, the measured electrical current (through resistor R) could be computed using equation (1). Additionally, considering  $r \ll R$  we have:

$$u(t) = E e^{-\frac{t}{RC}} \quad (1)$$

$$R = \frac{E}{i(0)} \quad (2)$$

$$\log_{10}(u(t)) = -\frac{1}{RC} \cdot t + \log_{10}(E) \quad (3)$$

#### 4. TEST STAND AND REQUIRED PERFORMANCE OF IT

In order to prove that the cells, even at worst conditions (short circuit), do not heat up so much to reach a dangerous threshold, tests should be done.

Another output of the test is the internal resistance of the galvanic element.

Also, by performing the short circuit test, it could be provided that the galvanic element container integrity is preserved in such a way to avoid the electrolyte leaks.

On the other hand, the discharging process of the galvanic element could reveal the inner equivalent capacitance.

In the figure 3 it is shown the proposed structure of the test stand.

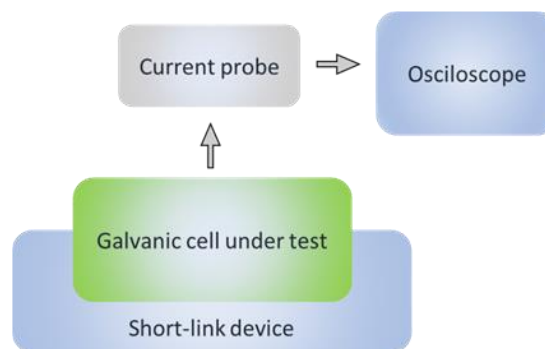

**Fig. 3.** Test stand - block diagram

As part of the test stand, a short-circuit link is the device which the galvanic element is connected at. To the short-circuit link is “connected” the galvanic isolated current probe. This current probe outputs the measurement converted as voltage. This signal is measured using an oscilloscope.

## SIMULATION OF GALVANIC ELEMENTS TESTED FOR EXPLOSIVE ATMOSPHERES

In order to ensure the quality of the measurement, the specific standard imposes that the short-circuit link device (excluding connections to it), shall not exceed  $3\text{ m}\Omega$  or voltage drop across it not to exceed  $0,2\text{ V}$  or  $15\%$  of the cell electromotive voltage.

For the purpose of data acquisition, based on observed dynamics of the current through the short-circuit link was concluded that one mega samples per second, was satisfactory.

### 5. TEST RESULTS AND DISCUSSIONS

A primary cell (which is not rechargeable) was tested using the above presented test stand, figure 4.

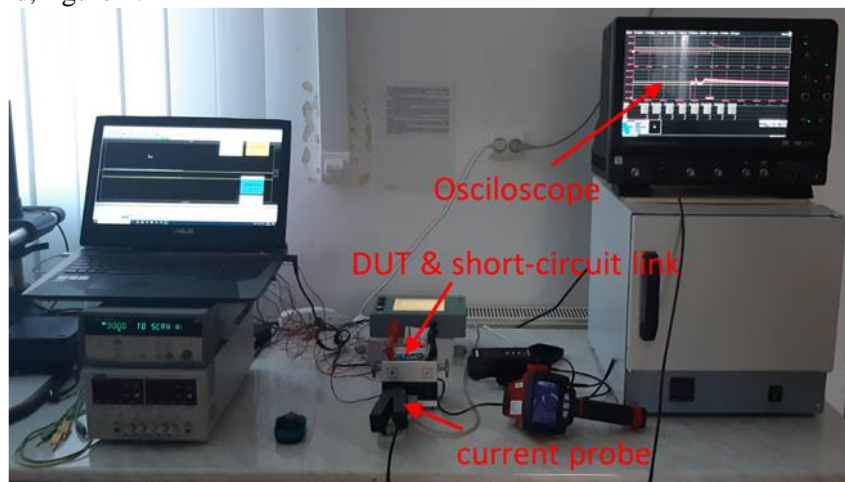

**Fig. 4.** Test stand

The discharge current (purple) measured through the galvanic element as function of time is presented in figure 5. Together with the discharge current, in figure 5 is presented the voltage (blue) across the galvanic element. All of those are shown as function of time and is expressed in seconds.

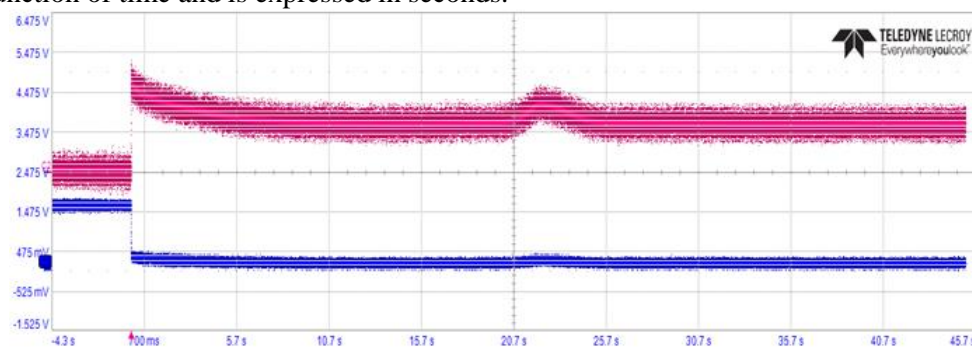

**Fig. 5.** The discharging current of galvanic element

For measuring the discharge current was used a current probe having conversion factor  $10\text{mV/A}$ . In order to avoid the overlapping of plots an offset for current was set up at  $2.475\text{ V}$ .

As it is shown in the diagram in figure 5 and 7, the maximum current is 23 A and the stabilized value of current is 12.5 A. According to equation (2) the value of R is 71.7 mΩ.

In the discharging process it can be seen another mild of current peak that shows a catalytic effect of specific temperature to the electrochemical process of the galvanic element.

The variation of the current at the very beginning of discharge process is presented in figure 6. The observed peaks are consequences of the lack of internal synchronization of the three transistors used for short-circuit link.

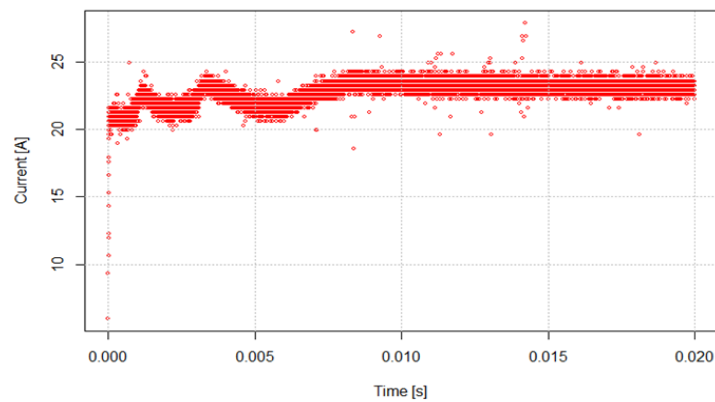

**Fig. 6.** The discharging current of galvanic element

For the discharge current, figure 7, was obtained by regression, an empiric function according equation (4).

$$i(t) = \frac{1}{(0,9825 \cdot t + 3,18437)^{1,891915} + 0,119549} \quad (4)$$

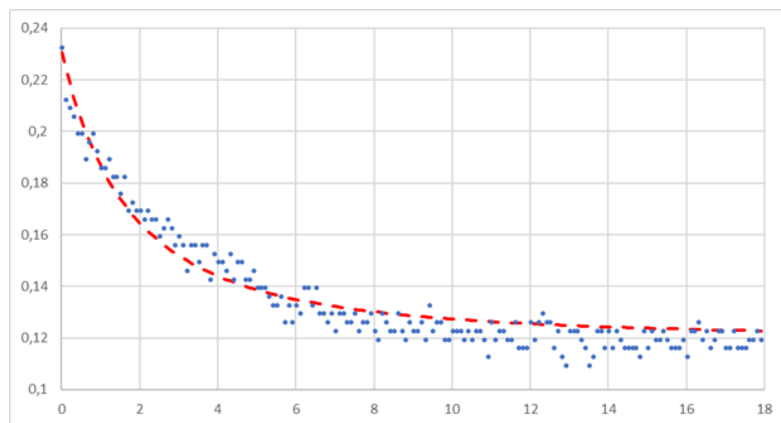

**Fig. 7.** The regression curve of discharging current of galvanic element

## SIMULATION OF GALVANIC ELEMENTS TESTED FOR EXPLOSIVE ATMOSPHERES

In the subdomain of time from 0 s to 50  $\mu$ s the logarithm of voltage values across the galvanic element variation is presented in figure 9. According to figure 9, the capacitive discharge is observed in the first 20  $\mu$ s. This phenomenon is explained by the linear variation of voltage logarithm in the first 20  $\mu$ s.

The parameters of regression line drawn in figure 9 are: slope  $-2.040 \cdot 10^4$  and intercept  $3.156 \cdot 10^{-2}$ .

Considering the equation (3),  $R=71.7$  m $\Omega$  and obtained slope it yields an equivalent capacity of 683.3  $\mu$ F.

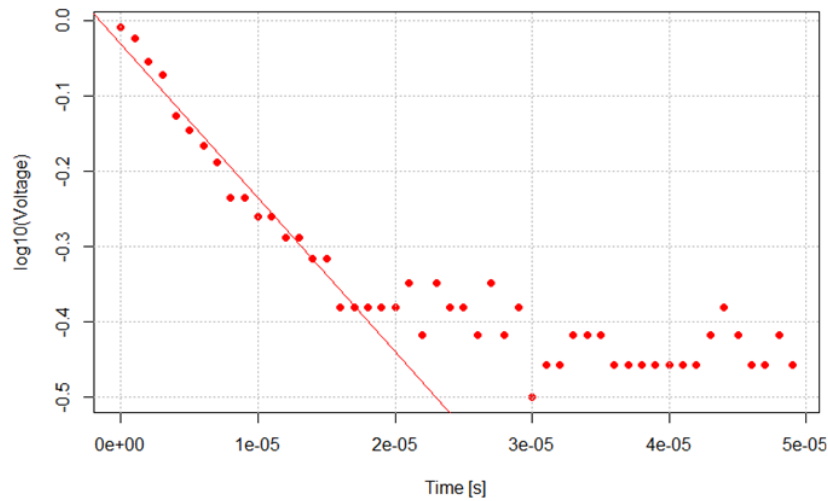

**Fig. 9.** Decimal logarithm of voltage in respect with time.

Taking into account the element voltage together with the inner capacitance, it could be concluded that 4 galvanic elements connected in series could ignite the hydrogen atmosphere, if a short circuit occurs.

The obtained value for intercept does not comply with the estimated value of  $\log_{10}(E=1.65V)$  according the equation (3).

Taking into account the measured values, the comparison of differences between decreasing time for voltage with decreasing time for current, shows a time dependence of E for the considered model.

## 6. CONCLUSIONS

A late mild pick of current in the discharging process was interpreted as catalytic effect of specific temperature to the electrochemical process of the galvanic element.

The variation of the current at the very beginning of the discharge (0-10 ms), shows consequences of the lack of internal synchronization of the three transistors used for short-circuit link.

A theoretical model was proposed for the galvanic element and the internal resistance was computed.

For the discharge current, an empiric function was obtained by regression. This one express quite well the current variation at the beginning of the discharge process.

The observed differences regarding the discharge dynamics for the voltage and for the current, leads towards to the time dependence for the internal source, in the proposed theoretical model.

The capacitive discharge was observed in the first 20  $\mu\text{s}$  by the linear variation of voltage logarithm in the first 20  $\mu\text{s}$ .

Using slope of voltage decimal logarithm, it was computed the equivalent capacitance of the galvanic element as being around of 683  $\mu\text{F}$ .

Taking into account the element voltage together with the inner capacitance it could be concluded that 4 galvanic elements connected in series could ignite the hydrogen atmosphere, if a short circuit occurs.

#### REFERENCES

[1]. **ATEX Directive**, *Equipment for potentially explosive atmospheres (ATEX)*, available [https://ec.europa.eu/growth/sectors/mechanical-engineering/atex\\_en](https://ec.europa.eu/growth/sectors/mechanical-engineering/atex_en), 2014.

[2]. **Moldovan L., Burian S., Magyari M., Darie M., Fotău D.**, *Factors influencing the determination of maximum surface temperature for explosion-proof luminaires*, Environmental Engineering and Management Journal, Vol.16, No. 6, pp 1309-1316, 2017.

[3]. \*\*\* **Standard (SR) EN 60079-0 (2013)** - *Explosive atmospheres - Part 0: Equipment - General requirements*.

[4]. \*\*\* **Standard (SR) EN 1127-1** - *Explosive atmospheres. Explosion prevention and protection. Basic concepts and methodology*, 2019.

[5]. \*\*\* **Standard (SR) EN 60079-11** - *Explosive atmospheres Equipment protection by intrinsic safety "i"*, 2012.

[6]. \*\*\* **IEC 60086-1:2015-Primary batteries - Part 1: General**.